



# CATALOG & WIRING GUIDE



[www.paigewire.com](http://www.paigewire.com)



# Contents

<b>WHY PAIGE</b>	3
<b>IRRIGATION</b>	
Wires and Cables	
Installation Tips	4
Power Wires	4 - 6
Control Valve Wires	7
Communication Cables	8
Decoder, 2-wire, 2-core cables	9
Decoder Cable Fuse Devices	10
Decoder Cable Fuse Devices, with Lightning Protection	11
Protecting Electric Equipment from Lightning and Power Surges	
Lightning arrester	12
Grounding controllers	12
Bonding controllers	13
Shielding underground wires and cables	13
Grounding decoder circuits	14 - 18
Bonding and shielding decoder circuits	14 - 18
Components for grounding, bonding and shielding	18
Installation tips for grounding, bonding and shielding	18 - 19
<b>SPLICE ACCESSORIES</b>	
Irrigation wire connectors, dry locations	20
Irrigation wire connectors, wet and damp locations	21 - 23
Wire Marking Tags	22
<b>LANDSCAPE LIGHTING</b>	
Low Voltage Lighting Cables	24
Timers	24
Photo Controls	24
Waterproof Connectors	25
Low Voltage Lighting Components	26
<b>CONTACTS</b>	27
<b>WARRANTY</b>	27



# Why Paige® ?

Because you need irrigation and lighting wires and cables made for professional use from a company:



**That thinks globally** and can provide products **international** and services in any country in the world

**Who understands** where you're coming from

**Who covers** the total spectrum of your cable and accessory needs

**Who can talk-the-talk** with your people

**Who from coast-to-coast** maintains the industry's largest, most comprehensive stock so your customers' needs are met promptly

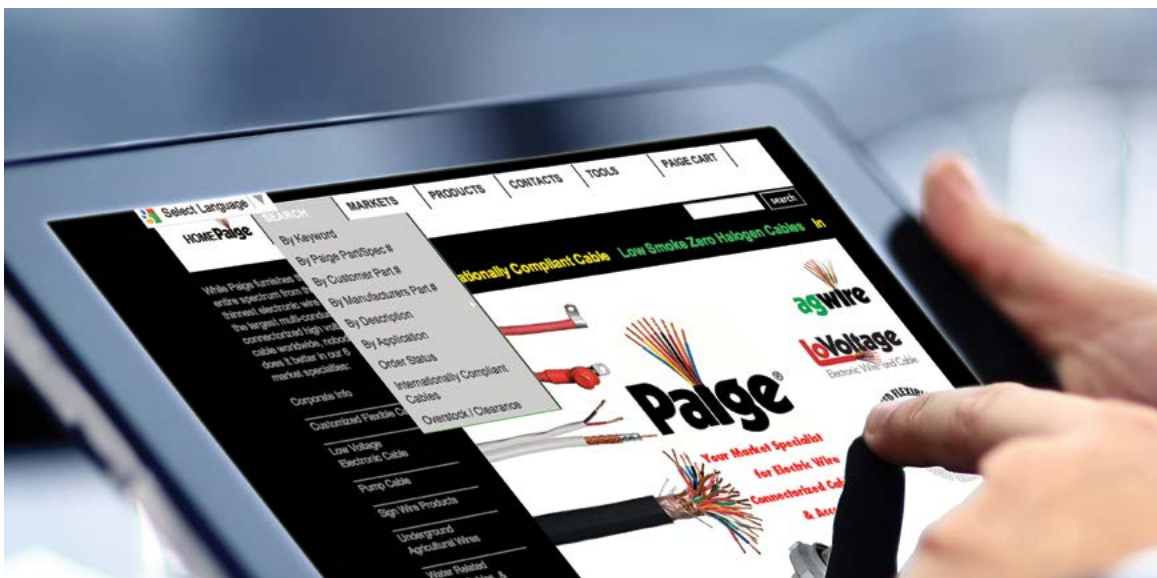

**From someone who answers** the phone when you call.

**Who's obsessed** with personal, immediate response, and service.

**Someone who delivers** the hard-to-find items.

**Someone who will develop** new wires & cables to meet your needs.

**Someone who will stock** a cable, when others won't.

**Someone with fast**, same-day shipping.

**Who's easy to do business with** – your **Paige** ally.

**Who takes your business personally.**



## INSTALLATION TIPS FOR WIRE & CABLE

Wire and cable burial depth is dictated by the National Electrical Code®. Temperature changes cause wires and cables to expand and contract as much as 1% of the length. And high voltage power lines create large electro-magnetic fields that cause interference and corrupt signals in communication lines. It is therefore necessary to take certain precautions when installing these products.

Wires and cables carrying up to 30 volts should be installed at a minimum burial depth of 6". If mechanical equipment, such as aerifiers and shovels, is expected to disturb the area, then the wires and cables should be installed at a minimum depth of 12". For wires and cables carrying more than 30 volts and less than 600 volts, the minimum burial should be 24".

For irrigation controller output cables carrying more than 30 volts, where the controller is listed as a "Power Limited Power Source" (Class 2 or Class 3), the burial depth is elective, although a minimum of 12" is recommended.

When installing wires and cables in a trench, they must be "snaked" so that some slack is created. At points along the trench where there are sharp bends, a loop of 12" to 24" shall be created to allow shrinkage. When communication cables are in the same trench as power wires, there shall be a minimum separation between them of 12".

## POWER WIRES for 120 VAC or 240 VAC Single Phase power sources to irrigation controllers (choose one of the following):

**SINGLE CONDUCTORS, TYPE UF** – This type of wire is a general purpose, direct burial, product that is widely used on all kinds of irrigation systems. Available from 14 AWG up to 1/0 AWG. See specification number P7001D for available colors and stripes. Detailed color code requirements are available from the American Society of Irrigation Consultants, ASIC Guideline 102-2004 ([www.asic.org](http://www.asic.org), "Design Guides".)



All branch circuit wires shall be type UF and sized according to the irrigation system plans. They are to be UL® listed for direct burial, and rated at 600 volts. The copper conductors shall be insulated with PVC and colored as follows:

120-volt system		240-volt system	
Hot	Black	Hot (Line 1)	Black
Neutral	White	Hot (Line 2)	Red
Equipment ground	Green	Equipment ground	Green

Paige Electric Co., LP specification number P7001D (<http://www.paigewire.com/specs/P7001D.htm>)

**SINGLE CONDUCTORS, TYPE THWN** – This type of wire is used in applications where the end user requires a high degree of safety and it must be installed in conduit. Available from 14 AWG up to 1000MCM AWG. See specification number P7316 for available colors. Detailed color code requirements are available from the American Society of Irrigation Consultants, ASIC Guideline 102-2004 ([www.asic.org](http://www.asic.org), “Design Guides”).



All branch circuit wires shall be type THWN and sized according to the irrigation system plans. These wires must be installed in conduit. The wires shall not occupy more than 40% of the cross-sectional area of the inner diameter of the conduit. They are to be UL® listed for in-conduit installations in wet applications, and rated at 600 volts. The copper conductors shall be insulated with PVC/Nylon and colored as follows:

120-volt system	
Hot	Black
Neutral	White
Equipment ground	Green

240-volt system	
Hot (Line 1)	Black
Hot (Line 2)	Red
Equipment ground	Green

Paige Electric Co., LP specification number P7316 (<http://www.paigewire.com/specs/P7316.htm>)

**TYPE UF-B CABLE (120 VAC SYSTEMS ONLY)** – This type of cable facilitates installation since the three conductors are installed within an outer jacket, which gives the cable more robust qualities. Available from 14 AWG/2c-with ground up to 6 AWG/2c-with ground.



All branch circuit power cables shall be type UF-B. They are to be UL® listed for direct burial, and rated at 600 volts. The cable shall include “three conductors”. The inner copper conductors shall be insulated with high dielectric PVC and Nylon. The outer jacket will be gray PVC and is to be sunlight resistant. The inner conductors are colored black, white, and bare copper.

Paige Electric Co., LP specification number P7295D (<http://www.paigewire.com/specs/P7295D.htm>)



photo: courtesy Hunter Industries

**TYPE TRAY CABLE** – This type of cable is widely used on large projects such as golf courses, parks, schools, commercial and industrial sites, cemeteries, etc., because of its ease of installation and toughness at a reasonable price. Available from 14 AWG/3c up to 4/0 AWG/3c. Detailed color code requirements are available from the American Society of Irrigation Consultants, ASIC Guideline 102-2004 ([www.asic.org](http://www.asic.org), “Design Guides”.)

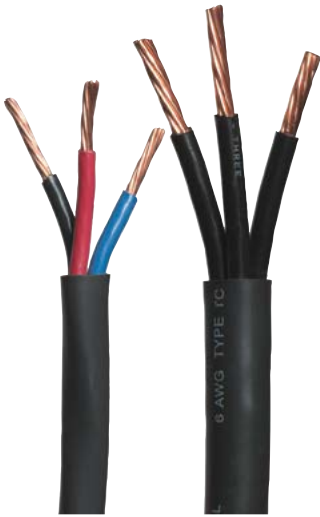

All branch circuit power cables shall be type Tray Cable. They are to be UL® listed for direct burial, and rated at 600 volts. The cable shall include “three conductors” (for 120 or 240 volt circuits.) The inner copper conductors shall be insulated with high dielectric PVC and Nylon. The outer jacket will be black PVC and is to be sunlight resistant. The inner conductors are colored (usually blue, red and black) or numbered (1, 2, and 3.) Inner conductors shall be color-coded at every splice and termination using Vinyl Electrical Color Coding Tape (3M #35) to National Electrical Code® and electrical industry standards, as per the chart below:

Conductor Color	Branch Circuit	
	120-volt	240-volt
	Tape Color	
Black	none	none
Red	white	none
Blue	green	green

For cables with colored inner conductors, color coding shall be executed as follows (note that color coding is different for 120-volt and 240-volt systems):

Conductor Color	Branch Circuit	
	120-volt	240-volt
	Tape Color	
Black (1)	none	none
Red (2)	white	red
Blue (3)	green	green

For cables with numbered inner conductors, color coding shall be executed as follows (note that color coding is different for 120-volt and 240-volt systems):

Paige Electric Co., LP specification number P7266D (<http://www.paigewire.com/specs/P7266D.htm>) for 10 AWG and smaller and specification number P7267D (<http://www.paigewire.com/specs/P7267D.htm>) for 8 AWG and larger.



photo: courtesy Hunter Industries

## CONTROL VALVE WIRES for 24 VAC (nominal) circuits (choose one of the following):

**SINGLE CONDUCTORS, TYPE UF/TWU** – This type of wire is a general purpose, direct burial, product that is widely used on all kinds of irrigation systems. Available from 14 AWG up to 1/0 AWG. See specification number P7001D for available colors and stripes.



Wires connecting the remote control valves to the irrigation controller shall be single conductors, type UF/TWU. Its construction incorporates a solid copper conductor and PVC insulation. The wires shall be listed for direct burial in irrigation systems and be rated at a minimum of 30 VAC. Wire sizes and colors are defined in the irrigation plans and other specifications.

Paige Electric Co., LP specification number P7001D (<http://www.paigewire.com/specs/P7001D.htm>)

*Note: White wires (or white with different color stripes) should be used only as the “common”. Green wire should not be used since this color is strictly reserved for the “equipment ground” of the power source. All other colors can be used as common or hot.*

**SINGLE CONDUCTORS, TYPE PE** – This type of wire, listed as Golf Course Sprinkler wire, was specifically designed for the harsh conditions of landscape projects where chemicals such as fertilizers, herbicides, pesticides, and fungicides are frequently applied. This product is excellent for these applications. See specification number P7079D for available colors and stripes.



Wires connecting the remote control valves to the irrigation controller shall be single conductors, type PE. Its construction incorporates a solid copper conductor and polyethylene (PE) insulation. The wires shall be listed for direct burial in irrigation systems and be rated at a minimum of 30 VAC. Wire sizes and colors are defined in the irrigation plans and other specifications.

Paige Electric Co., LP specification number P7079D (<http://www.paigewire.com/specs/P7079D.htm>)

*Note: White wires (or white with different color stripes) should be used only as the “common”. Green wire should not be used since this color is strictly reserved for the “equipment ground” of the power source. All other colors can be used as common or hot.*

**“18-MULTI”** – This direct burial cable is available with varying numbers of 18 AWG conductors, ranging from 2 to 25. It is used primarily in residential and small commercial irrigation projects.



The irrigation cable shall incorporate enough wires to accommodate all the valves it is designed to control, plus some spares for future expansion. For example, if the cable will activate 6 valves, then the number of wires needed is: 6 hot + 1 common + 2 spares = 9 wires. This cable would be called out as 18 AWG/9c. The construction shall include insulated solid copper conductors and an overall PE jacket. The cable shall be listed as Underground Low Energy Circuit Cable.

Paige Electric Co., LP specification number P7183D (<http://www.paigewire.com/specs/P7183D.htm>)

## COMMUNICATION CABLES (choose one of the following):



Compatible with **Toro SYSTEMS** – Typically uses a 16 AWG/1-pair cable. It is available as shielded or shielded/armored. The latter is rodent and lightning resistant. (Choose one of the following):

**SHIELDED** – The communication cable shall be 16 AWG/1-pair. The construction shall include tin coated copper conductors, an aluminum shield to prevent cross-talk, a drain wire for grounding the cable, and an overall PE jacket. The cable shall be listed for direct burial.

Paige Electric Co., LP specification number P7162D (<http://www.paigewire.com/specs/P7162D.htm>)

**SHIELDED AND ARMORED** - The communication cable shall be 16 AWG/1-pair. The construction shall include tin coated copper conductors, an aluminum shield to prevent cross-talk, a drain wire for grounding the cable, a stainless steel tape (also to be grounded) helically wrapped around the pair of wires, and an overall PVC jacket. The cable shall be listed for direct burial.

Paige Electric Co., LP specification number P7162D-A (<http://www.paigewire.com/specs/P7162D-A.htm>)



Compatible with **RAIN BIRD SYSTEMS** – Typically uses a 14 AWG/2c or 12 AWG/2c “Maxi” cable, or 19 AWG/multi-pair cable for “Maxicom” systems. Rain Bird allows MAXICOM cable to be any of the following types: PE-39, PE-54, or PE-89. See specification number P7072D for available outer jacket colors of Maxi cable.

**MAXI SYSTEMS** - The communication cable shall be 14 AWG/2c or 12 AWG/2c, as shown on the irrigation plans and specifications. The cable shall include two type UF/TWU wires with a PE outer jacket. The colors of the outer jacket shall be as called-for in the irrigation plans and specifications.

Paige Electric Co., LP specification number P7072D (<http://www.paigewire.com/specs/P7072D.htm>)

**MAXICOM SYSTEMS** - The communication cable shall be 19 AWG with a minimum of 3-pairs (or 6-pairs or 12-pairs, etc.) The cable construction shall be type PE-39 or PE-54 or PE-89. Paige Electric Co., LP specification number P7315D (for PE-39, & PE-54, or PE-89).

(<http://www.paigewire.com/specs/P7073D.htm> and <http://www.paigewire.com/specs/P7315D.htm>)



Compatible with **HUNTER SYSTEMS, WEATHER STATIONS, SENSORS, TELEPHONE LINES, ETC** – Typically use an 18 AWG/2-pair cable. It is available as shielded or shielded/armored. The latter is rodent and lightning resistant. (Choose one of the following):

**SHIELDED** – The communication cable shall be 18 AWG/2-pair. The construction shall include tin coated copper conductors, an aluminum shield to prevent cross-talk, a drain wire for grounding the cable, and an overall PE jacket. The cable shall be listed for direct burial.

Paige Electric Co., LP specification number P7171D (<http://www.paigewire.com/specs/P7171D.htm>)

**SHIELDED AND ARMORED** - The communication cable shall be 18 AWG/2-pair. The construction shall include tin coated copper conductors, an aluminum shield to prevent cross-talk, a drain wire for grounding the cable, a stainless steel tape (also to be grounded) helically wrapped around the pairs of wires, and an overall PVC jacket. The cable shall be listed for direct burial.

Paige Electric Co., LP specification number P7171D-A (<http://www.paigewire.com/specs/P7171D-A.htm>)

Rain Bird, Maxi and MAXICOM are trademarks of Rain Bird Corporation; Toro is a trademark of The Toro Company; Hunter is a trademark of Hunter Industries Inc.



## DECODER AND 2-WIRE/2-CORE CABLES – Custom cables have been designed by Paige Electric for various manufacturers of decoder systems, each somewhat different. (choose one of the following):

Compatible with **TORO SYSTEMS** – These cables feature 2 twisted wires, so that they stay together during the installation process and offer some opposition to electrical flow during lightning strikes. These twisted pairs are available in 9 different color combinations.

They are also available with a tough High Density Polyethylene outer jacket for additional mechanical strength. The outer jacket is a loose tube that slides off easily when being removed and is available in 6 different colors per size to facilitate circuit identification. This cable is specifically designed for the harsh conditions of landscape projects where chemicals such as fertilizers, herbicides, pesticides, and fungicides are frequently applied. Available in 14 AWG/2c and 12AWG/2c constructions.



**WITHOUT OUTER JACKET:** The decoder cable shall consist of 2 wires, twisted together. Its construction shall incorporate solid copper conductors with an extra-thick PE insulation with a minimum wall thickness of 0.075”.

Paige Electric Co., LP specification number P7389D (<http://www.paigewire.com/specs/P7389.htm>)



**WITH OUTER JACKET:** The decoder cable shall consist of 2 wires, twisted together. Its construction shall incorporate solid copper conductors with PE insulation. A loose tube-High Density Polyethylene jacket shall cover the twisted wires. The jacket colors shall be such as to facilitate the identification

of the various zones. Paige Electric Co., LP specification number P7350D (<http://www.paigewire.com/specs/P7350.htm>)

Compatible with **RAIN BIRD, BASELINE, AND UNDERHILL SYSTEMS** – These decoder systems utilize 14 AWG/2c or 12 AWG/2c cable. See specification number P7072D for available outer jacket colors. The decoder cable shall be 14 AWG/2c or 12 AWG/2c cable as shown on the irrigation plans and specifications. The cable shall include two type UF/TWU wires with a PE outer jacket. The colors of the outer jacket shall be as called-for in the irrigation plans and specifications.



Paige Electric Co., LP specification number P7072D (<http://www.paigewire.com/specs/P7072D.htm>)

Compatible with **HUNTER SYSTEMS** – These cables feature 2 twisted wires, so that they stay together during the installation process and offer some opposition to electrical flow during lightning strikes. They are also available with a tough High Density Polyethylene outer jacket for additional mechanical strength. The outer jacket is a loose tube that slides off easily when being removed and is available in 6 different colors per size to facilitate circuit identification. This cable is specifically designed for the harsh conditions of landscape projects where chemicals such as fertilizers, herbicides, pesticides, and fungicides are frequently applied. Available in 14 AWG/2c and 12AWG/2c constructions.



**WITHOUT OUTER JACKET:** The decoder cable shall consist of 2 wires, twisted together. Its construction shall incorporate solid copper conductors with an extra-thick PE insulation with a minimum wall thickness of 0.060”. Paige Electric Co., LP specification number P7313D (<http://www.paigewire.com/specs/P7313D.htm>)



**WITH OUTER JACKET:** The decoder cable shall consist of 2 wires, twisted together. Its construction shall incorporate solid copper conductors with PE insulation. A loose tube-High Density Polyethylene jacket shall cover the twisted wires. The jacket colors shall be such as to facilitate the identification of the various

zones. Paige Electric Co., LP specification number P7354D (<http://www.paigewire.com/specs/P7354D.htm>)

Rain Bird, Maxi and Maxicom are trademarks of Rain Bird Corporation; Toro is a trademark of The Toro Company; Hunter is a trademark of Hunter Industries Inc; Baseline is a trademark of Baseline, Inc.; Underhill is a trademark of Underhill International Corp.

# DECODER CABLE FUSE DEVICES (DCFD)<sup>TM</sup>, WITHOUT LIGHTNING PROTECTION



These products were specifically designed as electrical isolation devices to help with troubleshooting of damaged or non-functioning 2-Wire irrigation systems. Single or multiple sections of the electrical circuit can be disconnected or isolated by simply removing a fuse, without cutting wires or undoing splices/joints. Patent Pending.

Paige Part No.	Description
270DCFD1	Decoder Cable Fuse Device (inline)
270DCFD	Decoder Cable Fuse Device (2-way)
270DCFD3	Decoder Cable Fuse Device (3-way)
270DCFD1L	Decoder Cable Fuse Device (inline) with Lightning Protection
270DCFDL	Decoder Cable Fuse Device (2-way) with Lightning Protection
270DCFD3L	Decoder Cable Fuse Device (3-way) with Lightning Protection

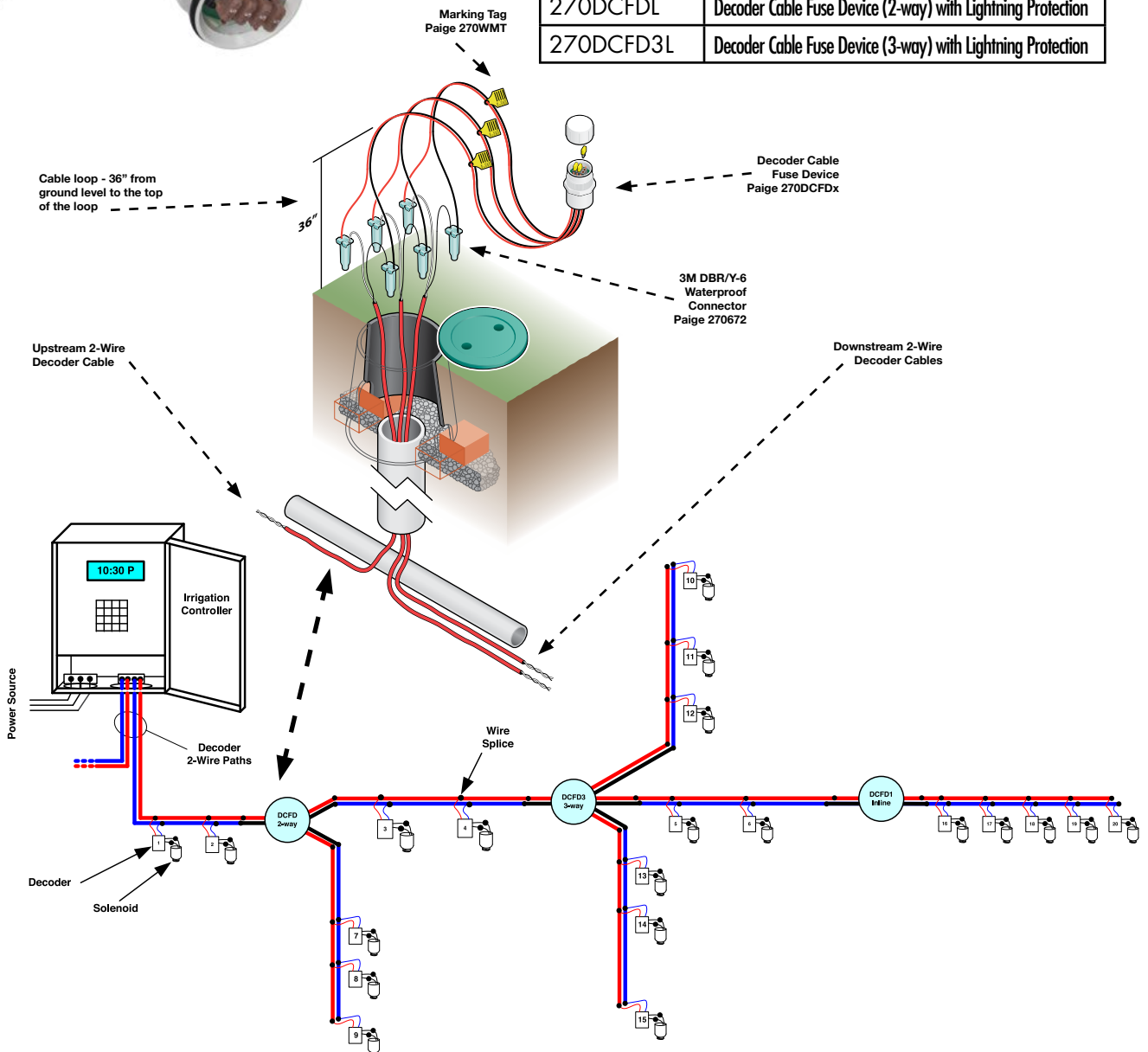

Paige Electric Co. LP specification number DCFD (<http://www.paigewire.com/specs/dcf.htm>)

# DECODER CABLE FUSE DEVICES (DCFD)<sup>TM</sup>, WITH LIGHTNING PROTECTION

These devices incorporate high surge current lightning arrester on the input and each of the output wires. This protects the DCFD and electronic equipment upstream and downstream.

Ratings for the surge arresters:

- DC sparkover trigger voltage of 75V
- 400 strikes at 1,000 amps, or
- 10 strikes at 20,000 amps, or
- 1 strike at 40,000 amps

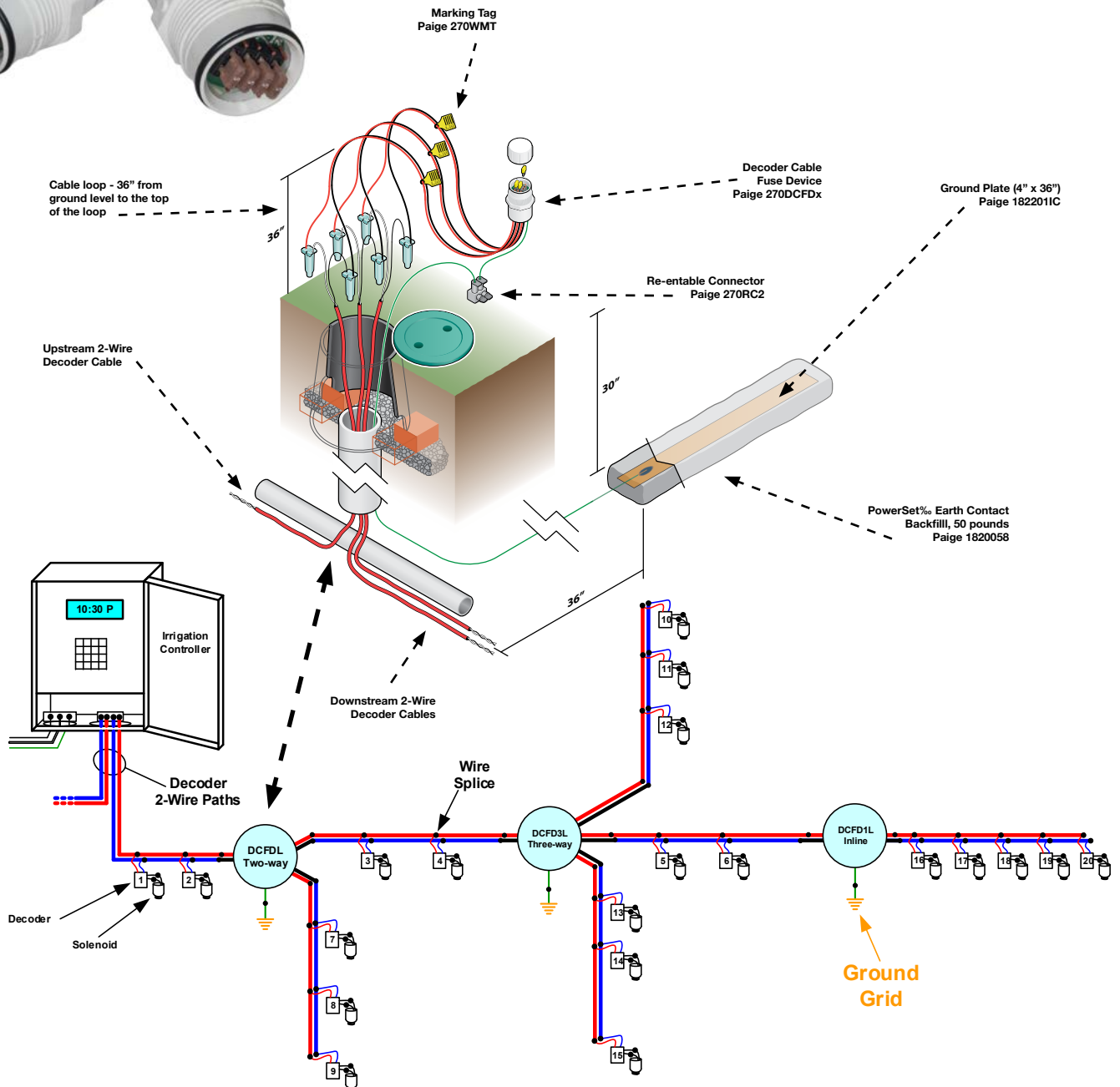

Paige Electric Co. LP specification number DCFD (<http://www.paigewire.com/specs/dcf.htm>)

# Paige® grounding systems

## PROTECTING ELECTRONIC EQUIPMENT FROM LIGHTNING AND POWER SURGES

Electronic irrigation equipment should be grounded to the earth, and bonded, in accordance with the requirements of the NEC®. Bonding wires should be installed so that they act as a shield to protect the wires in the trench from lightning strikes. Lightning arresters should be incorporated into the electronic equipment if not already supplied by its manufacturer. Below are specific details and recommendations from Paige Electric.



### LIGHTNING ARRESTERS

Most irrigation controllers are supplied with lightning protection on the secondary circuits, but not on the incoming power wires.

The Paige Electric 250090LED arrester can be used to protect the controller from surges coming from the 120 or 240 Vac wires. This arrester incorporates a visible green LED to indicate that the unit is ready to fire in case of a power or lightning surge. It should be replaced when the LED is not lit.

The Paige Electric 270SSG Surge Guard arrester is designed to protect Irrigation decoder two-wire paths and solenoids from power and lightning surges. It can also be used to protect Landscape Lighting fixtures. [http://www.paigewire.com/Specs/lightning\\_arresters.htm](http://www.paigewire.com/Specs/lightning_arresters.htm)

### GROUNDING CONTROLLERS

The following details are the minimum requirement for supplementary grounding and bonding of any irrigation controller, weather station, interface, etc. Other details, for a multitude of field situations, are available from the American Society of Irrigation Consultants, ASIC Guideline 100-2002 ([www ASIC.org](http://www ASIC.org), "Design Guides".)

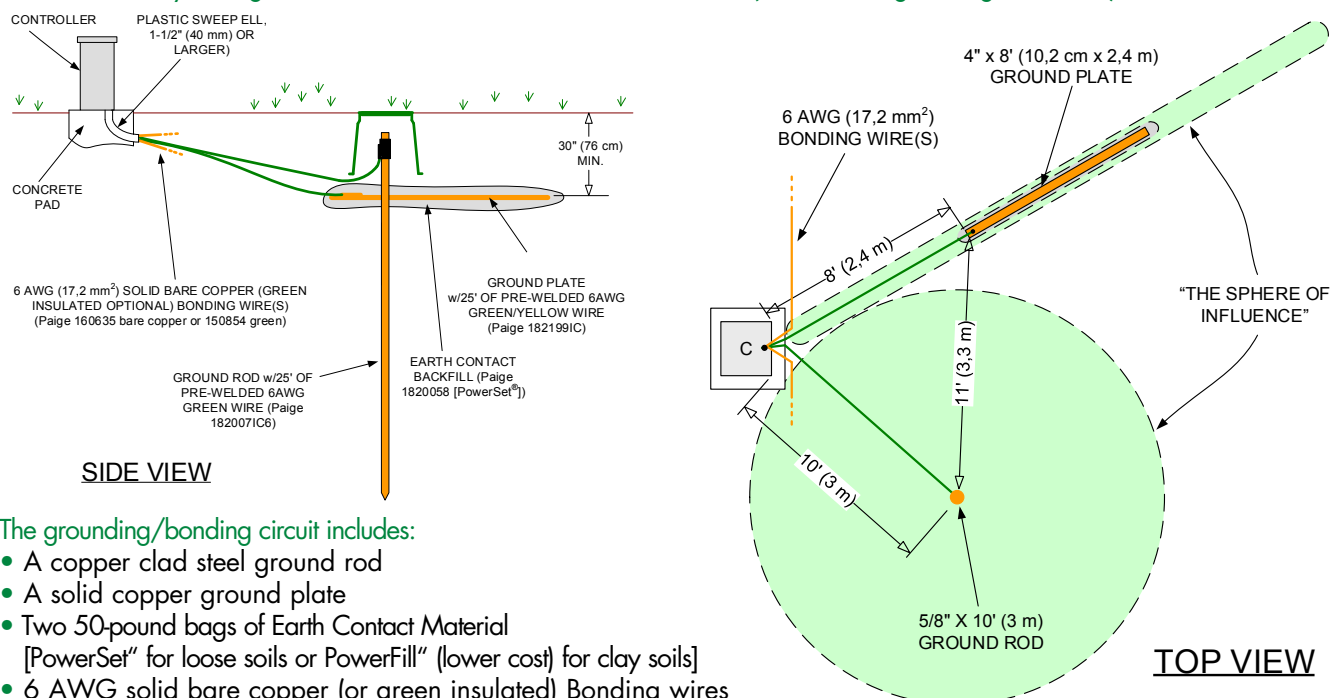

The grounding/bonding circuit includes:

- A copper clad steel ground rod
- A solid copper ground plate
- Two 50-pound bags of Earth Contact Material [PowerSet™ for loose soils or PowerFill™ (lower cost) for clay soils]
- 6 AWG solid bare copper (or green insulated) Bonding wires

## BONDING CONTROLLERS

The grounding of an irrigation controller is referred to by NEC® as "Supplementary or Auxiliary grounding." And for safety reasons, the NEC® requires that all supplementary grounds be "bonded" to each other and to the service entrance ground (power source) as shown below.

This is also a "recommended practice" of The Institute of Electrical and Electronics Engineers (IEEE Standard 1100-1999.) Note that the bonding wires are in addition to the equipment ground, which is commonly referred to as "the green wire." For 120

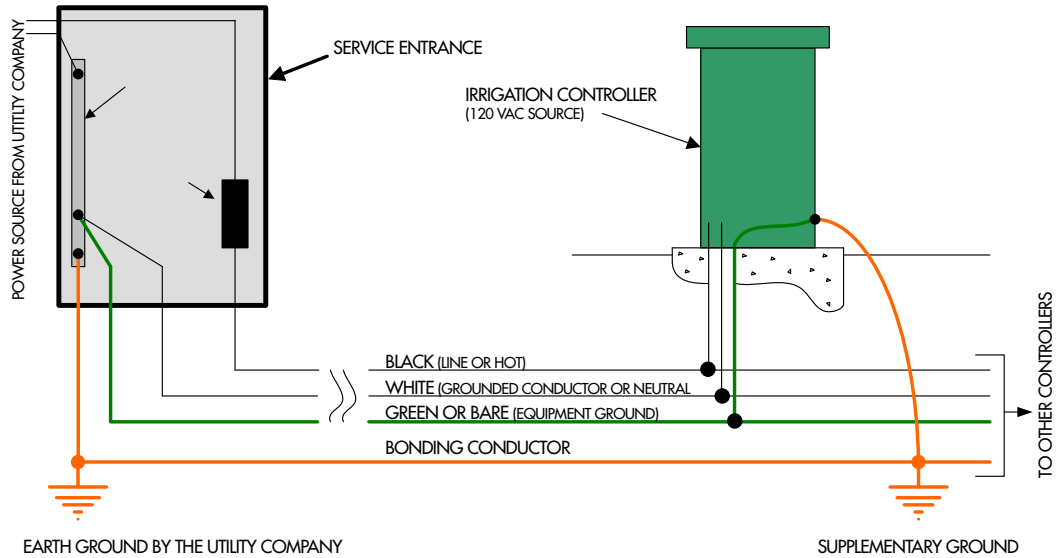

Vac power sources, the wires are Black, White and Green. For 240 Vac power sources, the wires are Black, Red and Green. Power wires must always be kept together in a trench, conduit, tray, etc. The bonding conductors are required to be 6 AWG solid bare copper, unless the system power conductors are larger than 1/0 AWG, in which case the bonding wires are to be 4 AWG solid bare copper.

## SHIELDING UNDERGROUND WIRES AND CABLES

The conductors that bond the controller ground grids to each other and their power source entrance can be installed so they also act as shielding conductors. This minimizes the induced voltages onto the wires in the trench, which protects the wires from lightning damage and reduces the possibility of damage to electronic equipment.

This becomes a network of solid bare copper wire over all the main bundles of other wires and cables as shown in the detail. The bare copper wire is to be installed as close to the surface as possible, yet being sufficiently below the ground level as to prevent damage from maintenance equipment such as aerifiers. And it must be placed above all other valve, power, and communication wires and cables, and installed in all trenches as shown on the electrical plan drawings. It is not necessary to install this conductor over short wire runs (less than 150 feet) away from the main wire bundles.

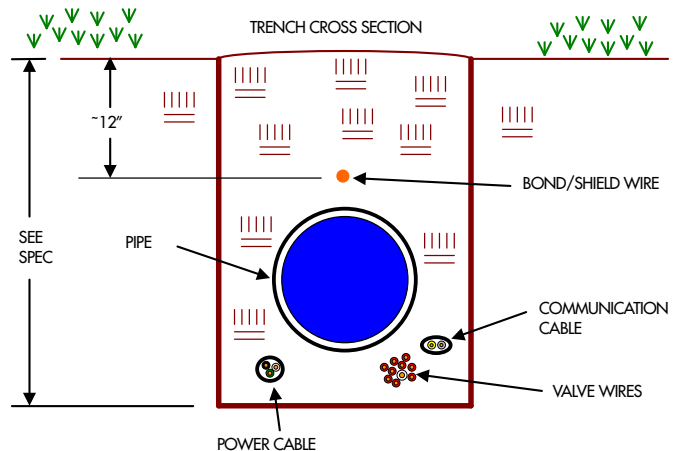

The conductor is laid in as straight a line as possible, and when necessary to make bends, do so in a sweeping motion as defined in the Installation section below. The shield network is to be connected to the service entrance earth ground, to all electronic equipment ground lugs, and all equipment supplementary grounding electrodes. One such network is necessary for each power source. **DO NOT INTERCONNECT THE EQUIPMENT GROUND WIRES FROM DIFFERENT POWER SOURCE SERVICE ENTRANCES.**

## GROUNDING DECODER CIRCUITS

In decoder systems, the lightning protection/arresters are either built into the decoder or they are wired externally, depending on the manufacturer. Without lightning arresters, the decoders are vulnerable to lightning damage. In order for these arresters to discharge lightning energy efficiently, they must be grounded.

## BONDING & SHIELDING DECODER CIRCUITS

It is important to maintain the same voltage at all points of the two wire path in order to minimize lightning damage.

The technique known as “bonding” is used to accomplish this by using a 10 AWG solid bare copper wire to interconnect all the decoder ground grids. This bonding wire can be used to “shield” the two wire paths from lightning energy by placing it directly (and-centered) above all the cables in the trench.

Here are typical recommended grounding grids for decoder and 2-Wire/2-Core systems, with internal and external lightning arresters:

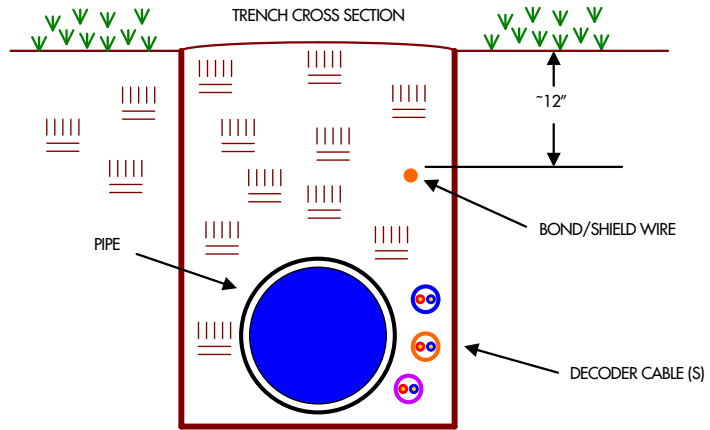

## DECODERS WITH GROUND WIRES & INTERNAL LIGHTNING ARRESTER, GROUNDED:

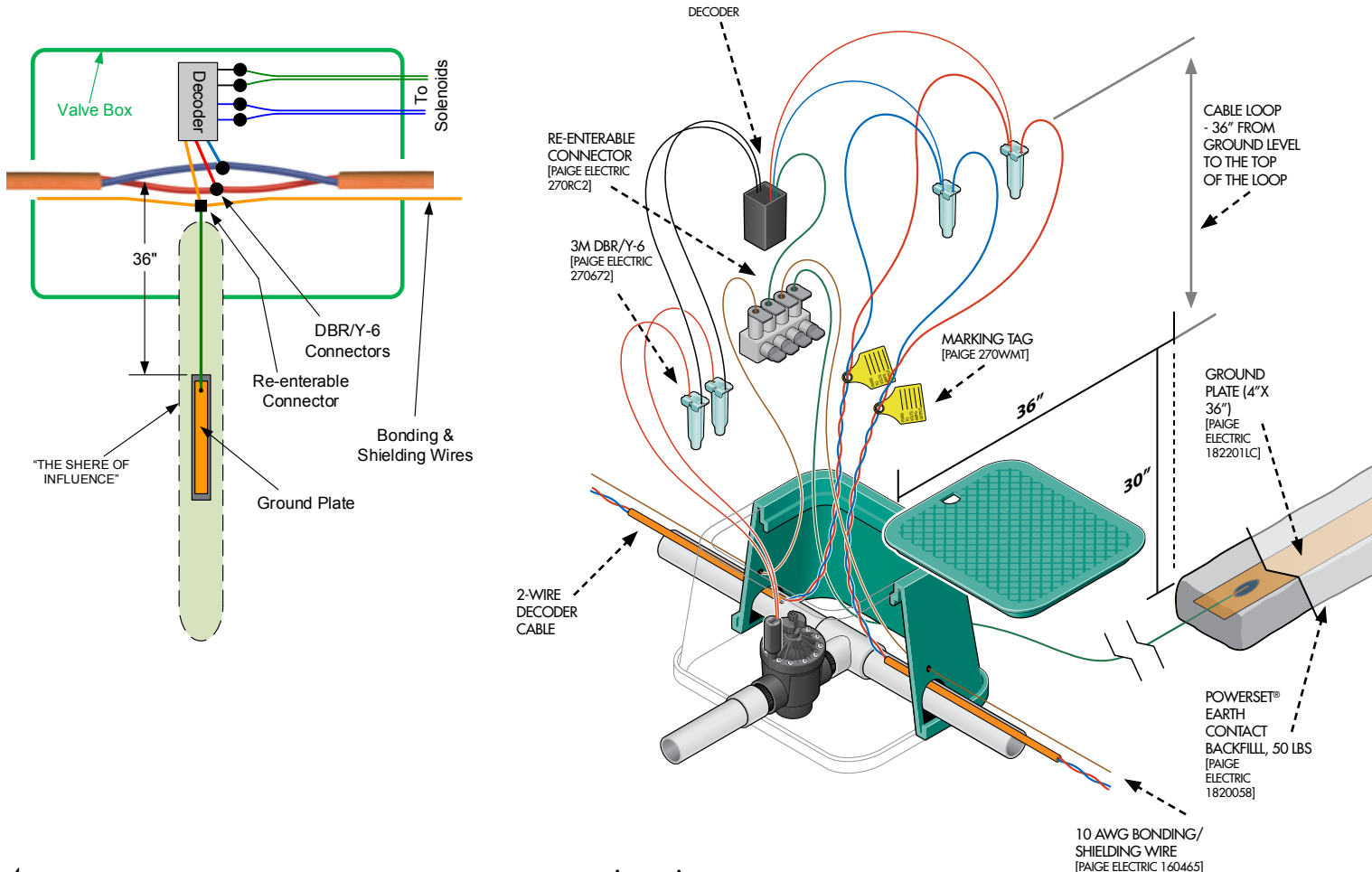

**DECODERS WITH GROUND WIRES & INTERNAL LIGHTNING ARRESTER, NOT GROUNDED:**

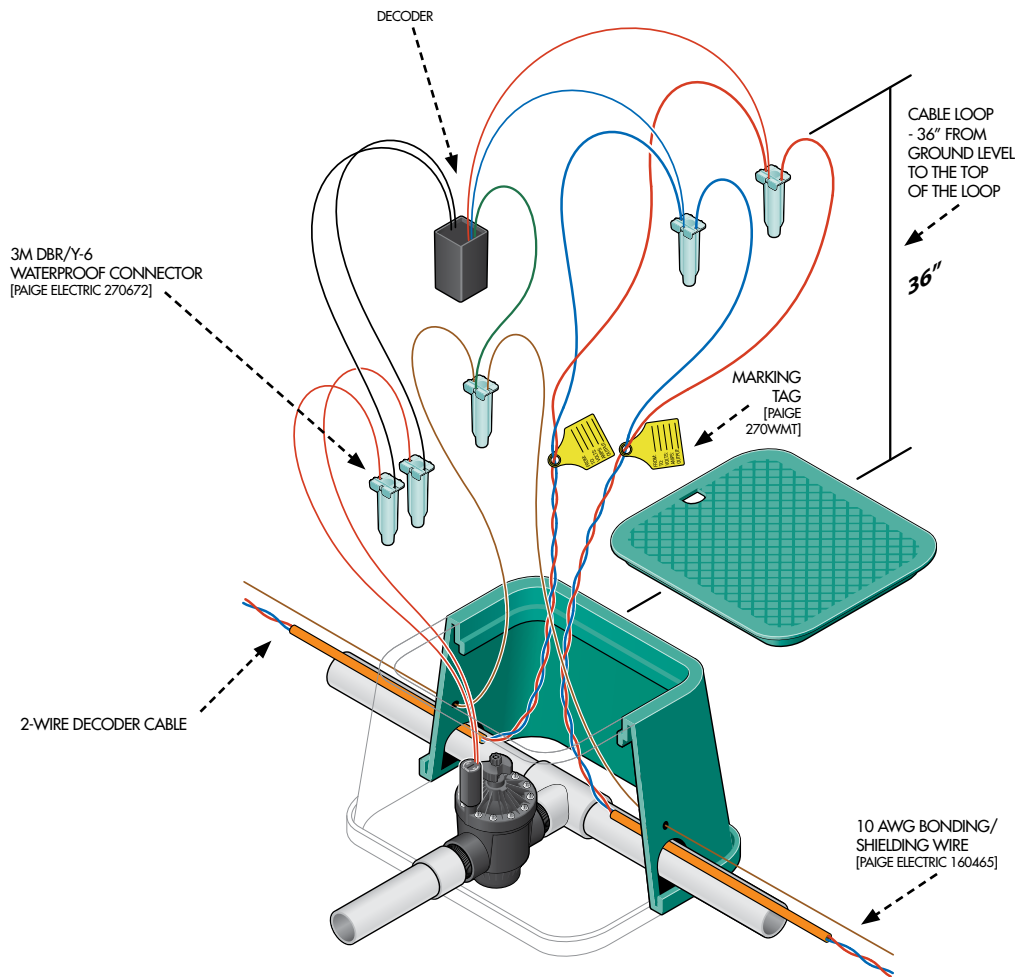
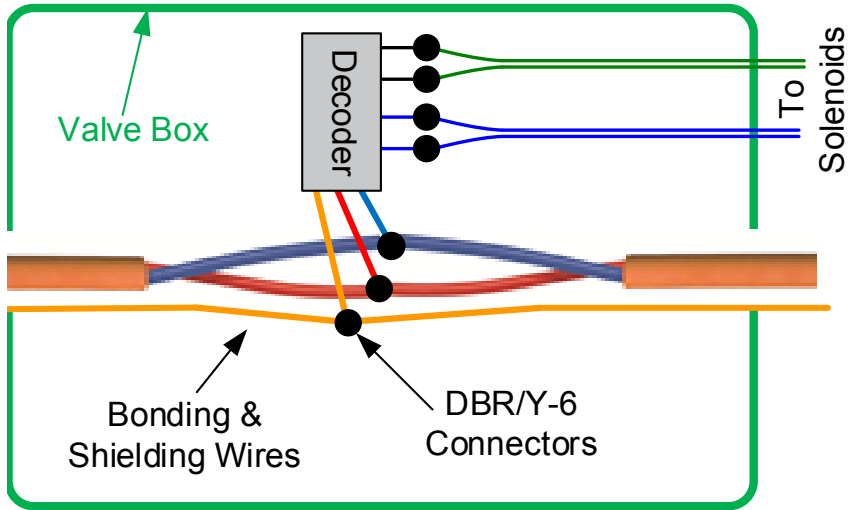

## DECODERS PROTECTED BY EXTERNAL LIGHTNING ARRESTER

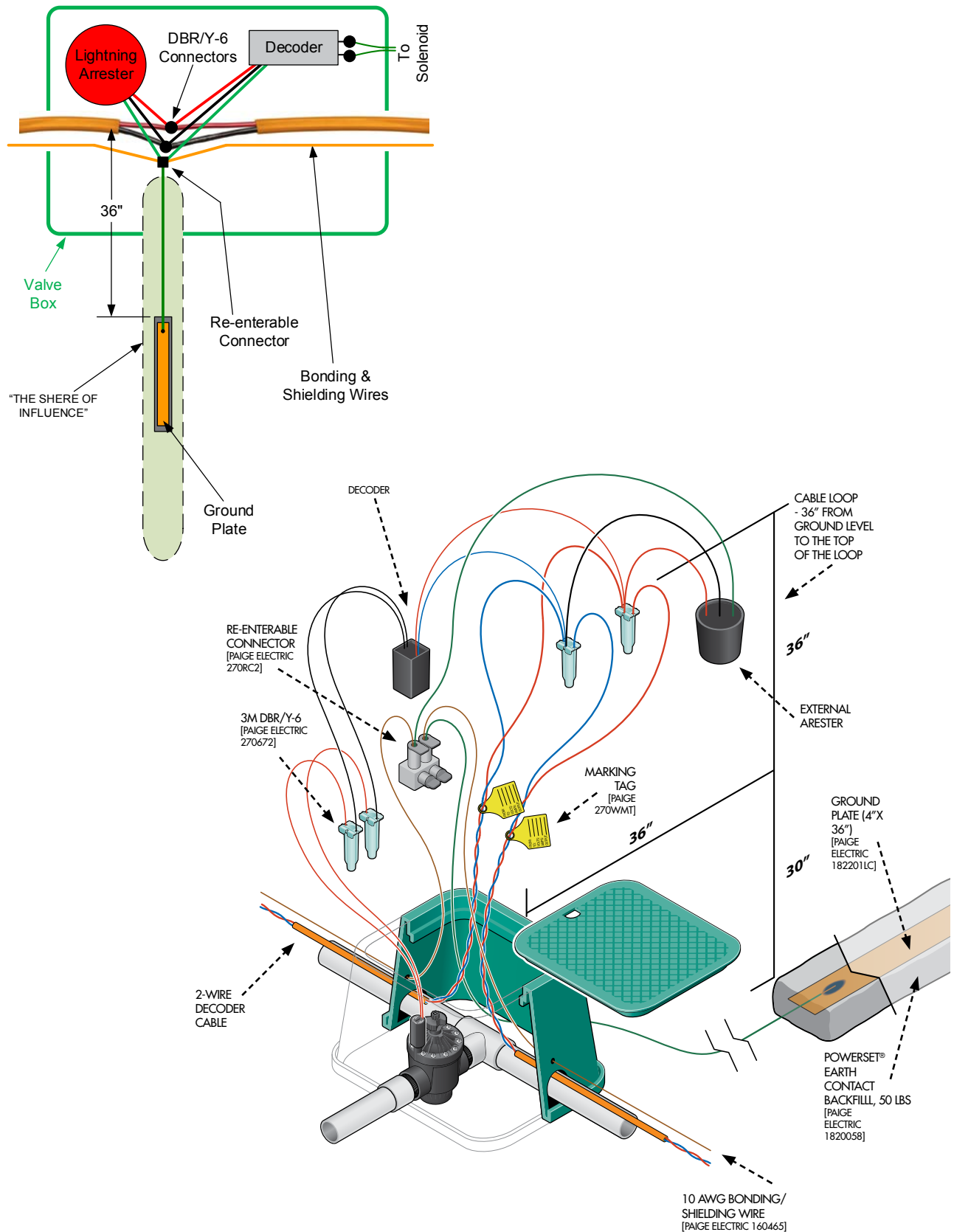



## 2-WIRE/2-CORE SYSTEMS WITH INTEGRATED DECODER & SOLENOID

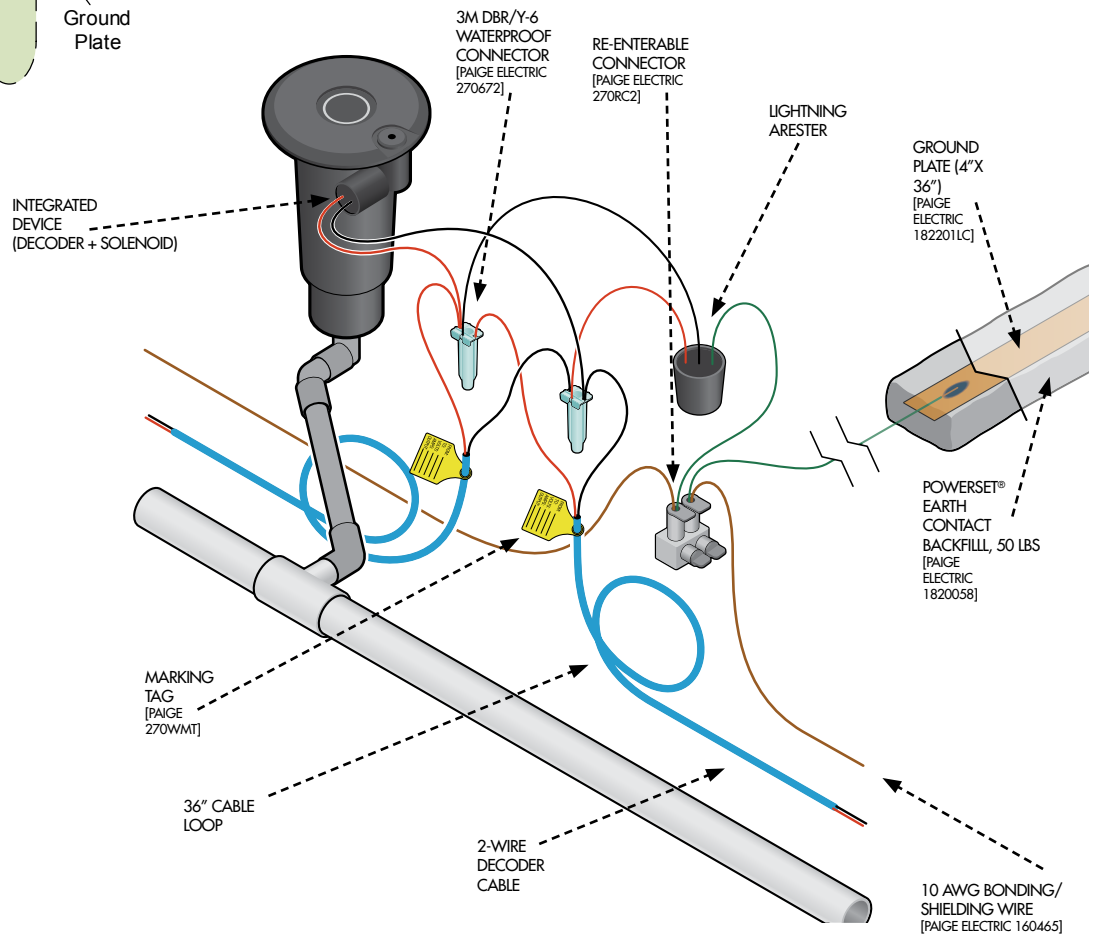
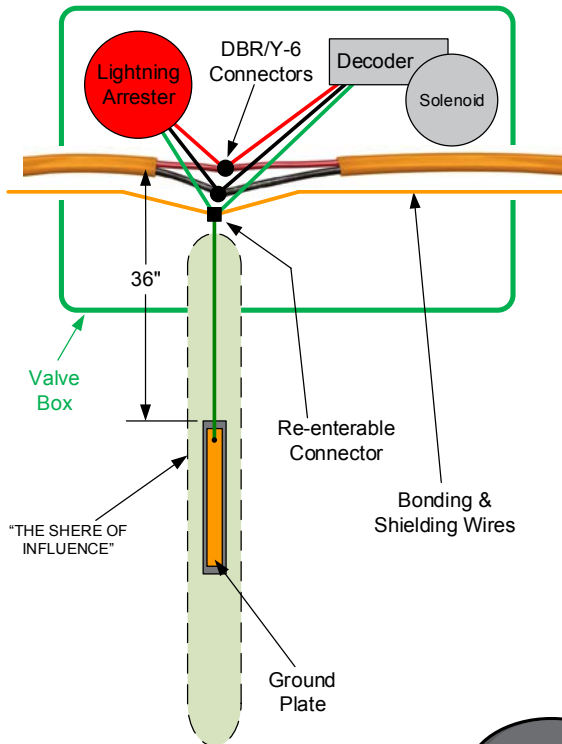

## GROUNDING/BONDING/SHIELDING COMPONENTS

Paige Part No.	Description
250090LED	Lightning Arrester with LED indicator
182199IC	4" x 96" x 0.064" Ground plate for controllers with 25' of 6 AWG insulated green wire with yellow stripe
182201IC	4" x 36" x 0.064" Ground plate for 2-Wire/2-Core circuits with 15' of 10 AWG insulated green wire with yellow stripe
182000	5/8" Diameter x 8' Long Ground rod
182007	5/8" Diameter x 10' Long Ground rod
182005	5/8" Ground rod clamp
182000IC10	5/8" Diameter x 8' long Ground rod with 15' of 10 AWG insulated green wire
182000IC6	5/8" Diameter x 8' long Ground rod with 15' of 6 AWG insulated green wire
182007IC6	5/8" Diameter x 10' long Ground rod with 25' of 6 AWG insulated green wire
160465	10 AWG solid bare copper wire
160635	6 AWG solid bare copper wire
150854	6 AWG solid copper, green ground wire
1820058	"PowerSet" Earth Contact Material
1820059	"PowerFill" Earth Contact Material
1820037P	Cadweld connector for one 6 or 8 AWG joint to a ground rod
1820074P	Cadweld connector for up to four 6 or 8 AWG bonding wires
1820040CU	Control Unit for igniting Cadweld

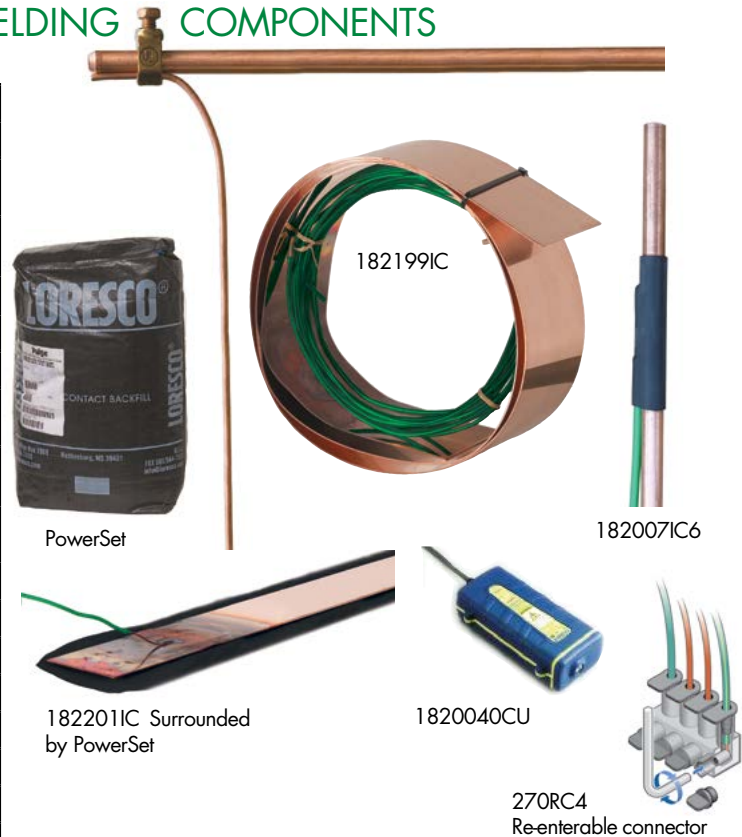

A more extensive list of available components can be viewed at:

Paige Electric Co., LP specification number DCFD (<http://www.paigewire.com/specs/P7345D.htm>)

## INSTALLATION TIPS FOR GROUNDING, BONDING, AND SHIELDING

Proper installation and maintenance of grounding, bonding, and shielding components is a critical part of the effectiveness of the grid in order to protect electronic equipment from lightning and power surges.

The ground grid components shall be installed with the dimensional relationships shown in the details above. WIRES, CABLES, AND ELECTRONIC EQUIPMENT MUST BE INSTALLED OUTSIDE "THE SPHERE OF INFLUENCE" OF THE GROUNDING ELECTRODES.

All underground splices to ground rods and bonding conductors are to be made using Cadweld "One-Shot" kits or Re-enterable connectors (2,3,4 or 6 positions).

The ground rod has a minimum diameter of 5/8" (16 mm) and a minimum length of 10 feet (3.05 m.) A 25-foot (7.62m) continuous length of 6 AWG, green insulated, solid bare copper wire is pre-welded to the ground rod. Heavy-duty adhesive-lined shrink tubing shall cover the weld joint to minimize corrosion and maintain the weld during the installation process. These are to be driven into the ground in a vertical position, or at an angle of up to 45 degrees. [Paige Electric part number 182007IC6.]

Copper ground plates are made of a copper alloy intended for grounding applications and have minimum dimensions as follows:

- **For grounding controllers** - 4" x 8' x 0.0625" (101.6 mm x 2.44 m x 1.6 mm.) A 25-foot (7.62 m) continuous length of 6 AWG, green insulated, with extruded yellow stripe, solid bare copper wire is welded to the plate. [Paige Electric part number 182199IC]
- **For grounding decoders and 2-Wire/2-Core circuits** - 4" x 3' x 0.0625" (101.6 mm x 2.44 m x 0.9 mm.) A 15-foot (4.57 m) continuous length of 10 AWG, green insulated, with extruded yellow stripe, solid bare copper wire is welded to the plate. [Paige Electric part number 182201IC]

The ground plates are to be installed to a minimum depth of 30" (76 cm), or below the frost line if it is lower than 30".

Two 50-pound bags of PowerSet® [Paige Electric part number 1820058] "Earth Contact Material" must be spread so that it surrounds the 8-foot copper plate evenly along its length within a 6" (152 mm) wide trench. Use one bag only for the installation of 3-foot ground plates. Salts, fertilizers, bentonite clay, cement, coke, carbon, and other chemicals are not to be used to improve soil conductivity because these materials are corrosive and will cause the copper electrodes to erode and become less effective with time. It is important that the Earth Contact Material completely surrounds the ground plate and 6" (152 mm) of the insulation of the green wire, as shown in the detail, in order to minimize corrosion.

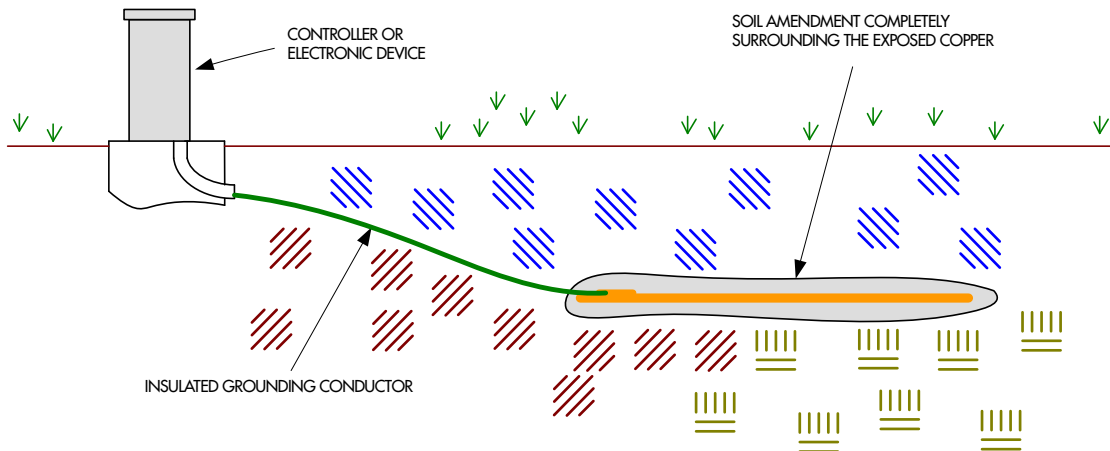

Install all grounding circuit components in straight lines and simple geometry. When necessary to bend wires, make sweeping turns as shown. All grounding and bonding wires of electronic equipment must be fed through a **dedicated 1.5" (38.1 mm) plastic sweep ell**. "Sweep bends" must follow the guidelines shown here.

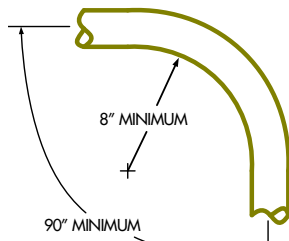

The 6 AWG bare copper wires are to be installed in as straight a line as possible, and if it is necessary to make a turn or a bend it shall be done in a sweeping curve with a minimum radius of 8" (203.2 mm) and a minimum included angle of 90°.

A convenient way to make connections to the controller ground lug is shown here. This type of installation, which utilizes a multi-position bus bar, allows for rapid connecting and disconnecting of desired wires in order to periodically take earth resistance readings of the individual grounding electrodes.

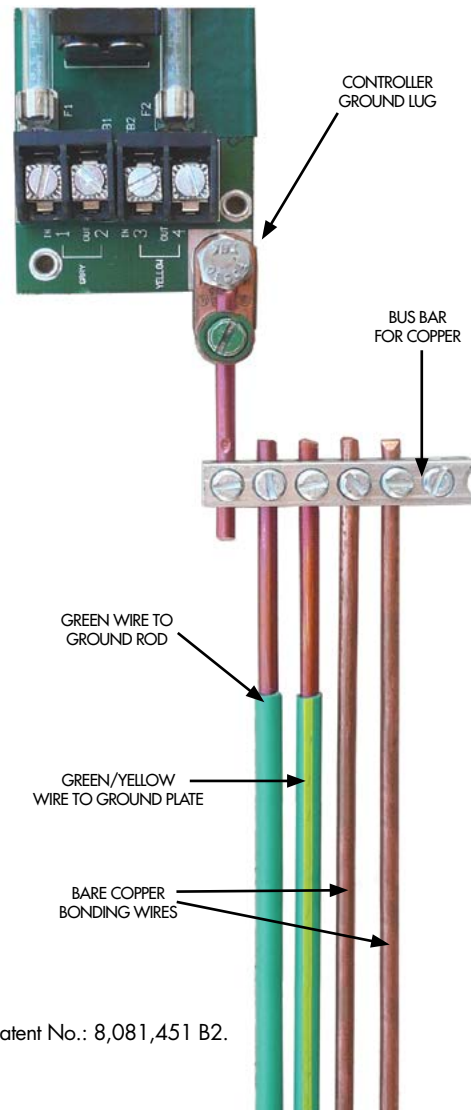

The earth-to-ground resistance should be measured at the time of installation using a "Megger", or other similar instrument, and the reading is to be no more than 10 Ohms. If the resistance is more than 10 ohms, additional ground plates and PowerSet® are to be installed using ASIC Guidelines 100-2002 ([www.asic.org](http://www.asic.org), "Design Guides".) It is required that the soil surrounding copper electrodes, within the Sphere of Influence, be kept at a minimum moisture level of 15% (by weight) at all times as dry soil does not conduct electricity.

**ALL GROUNDING COMPONENTS MUST BE CONNECTED TO THE EQUIPMENT BEFORE ANY OTHER CONNECTION IS MADE.**

United States Patent No.: 8,081,451 B2.



## IRRIGATION WIRE & CABLE SPLICES

Connections (splices/joints) are the weak link of any electrical circuit. These must be made properly, with appropriate products, in order to ensure long term system reliability. This is particularly important in Decoder, 2-Wire, and 2-Core systems.

All electrical connections should incorporate:

1. A solid mechanical connection of the copper conductors using a UL-listed device (twist-on connector, split bolt, butt connector, insulation displacement connector, etc.)
2. Electrical insulation of the mechanical connection, if not part of the mechanical connector
3. A means to waterproof the insulated connection
4. "Strain relief" to prevent the connection from coming apart when wires/cables are pulled-upon
5. A design that is forgiving of human error

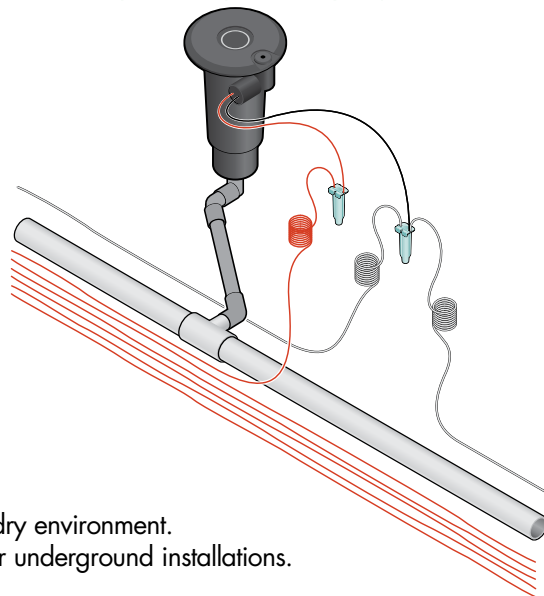

## MECHANICAL CONNECTORS

These connectors are for above ground installations, in a dry environment. They can also be immersed in waterproof resins or gels for underground installations.



Twist-on connectors (aka wire nuts) – The new 3M "Performance Plus" connectors have an incredible bite. They grab the wires quickly and twist them together with ease. The wings make it easy on the fingers!

Split bolts – This type of connector is usually used when making electrical connections for irrigation power wires.

They are then wrapped with electrical or rubber tape before immersion into a waterproof resin bag (3M #4) or resin-filled plastic tube (3M 82A Series.)

Paige Electric Co., LP specifications ([http://www.paigewire.com/Specs/wire\\_connectors.htm](http://www.paigewire.com/Specs/wire_connectors.htm))



## WATERPROOF CONNECTORS FOR IRRIGATION SYSTEMS

These gel-filled connectors are used for above or below grade applications, in damp or wet environments.

**DBR/Y-6 and DBO/B-6** – These new connectors from 3M incorporates the great features of a “Performance Plus” wire nut with the proven reliability of the DBY/DBR series that was the backbone of the irrigation industry for over 20 years. These UL-listed products (Direct Burial, file E102356) can be used with confidence on any irrigation system, especially 2-Wire/2-Core.



**DB144** – This product was the recipient of the 2006 Irrigation Association Product of the Year Award. It utilizes a 3-position bus bar, where each position will accept a wide range of wire size combinations up to three 4 AWG.

**316IR & MGC** - These UL-listed products (Wire Connectors and Soldering Lugs, file E23438) are a low cost solution for reliable connections/joints of “valve wires” to the solenoids of conventional irrigation systems. There is no stripping of the wires required, which means lower labor costs.

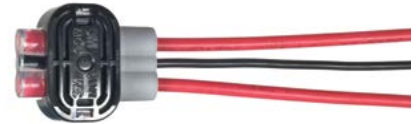

Paige Electric Co., LP specifications ([http://www.paigewire.com/pb\\_category.aspx?cat=16](http://www.paigewire.com/pb_category.aspx?cat=16))

## SILICONE FILLED WIRE CONNECTORS

This family of UL and CSA listed silicone-filled wire connectors was specifically designed for use in professionally installed irrigation control and landscape lighting systems. These connectors provide a secure electrical connection for two or more pre-stripped copper wires and seal the connection for use in damp/wet locations or direct bury applications. Connected and protected in one easy, time-saving process.



**WeatherProof™ Wire Connectors:** - For installation in dry or damp locations

Part Numbers and Description													
													
		Gray/Orange				Gray/Red				Gray/Dark Blue			
Wire Range	AWG	22-14				18-8				16-6			
	mm <sup>2</sup>	0.34 to 2.5				0.75 to 10				1.5 to 16			
Replaces King		Black/White, Gray/Gray, Aqua/Orange, Blue/Blue				Black/Gray, Aqua/Red, Tan				Black/Blue, Aqua/Blue			
Packaging Details		Pack	Case Qty	Paige #	Ideal #	Pack	Case Qty	Paige #	Ideal #	Pack	Case Qty	Paige #	Ideal #
		Card of 25	125	270i61B	30-1161	Card of 20	100	270i62B	30-1162	Card of 15	75	270i63B	30-1163
		Jar of 150	900	270i61J	30-1261J	Jar of 100	600	270i62J	30-1262J	Jar of 50	300	270i63J	30-1263J
		Box of 1000	1,000	270i61D	30-1361	Box of 1000	1,000	270i62D	30-1362	Box of 1000	1,000	270i63D	30-1363

## RESINS

Resin kits use a two-part epoxy especially designed to waterproof wires that have been mechanically joined using wire nuts, split bolts, etc.

### 3570GN AND 4N SERIES

This 3M Scotchcast resin is a two-part epoxy insulating and encapsulating resin packaged in several sizes

### 82-AN SERIES AND 82-B1N

Use the 3M Scotchcast 82-AN and 82-B1N series kits to insulate and seal single wire and cable splices. The 82-AN Series is for inline splices and the 82-B1N is for "wye" splices. Each kit contains:



- A snap-together mold body
- 2 Funnels
- Rubber tape for sealing mold ends and connector area
- Scotchcast 4N electrical insulating resin

Paige Electric Co., LP specifications  
[http://www.paigewire.com/pb\\_category.aspx?cat=16](http://www.paigewire.com/pb_category.aspx?cat=16)



## MISCELLANEOUS ACCESSORIES

### Cable Stripping Tools

Part No.	For removing cable Outer jackets of:
270004	Any round cable with 0.18" to 10.0" 
2700041	<ul style="list-style-type: none"> <li>• Rain Bird 2-Wire and Maxi systems</li> <li>• Type UF-B</li> </ul> 

### Scotchkote Electrical Coating

3M(TM) Scotchkote(TM) Electrical Coating FD is a fast-drying sealant and bonding compound designed to improve weather resistance of taped splices. For direct burial, direct water immersion or above-ground applications. Paige 270388



### Power Cords

Part No.	Description	Part No.	Description
0900820DST	6' Straight Plug	0900825G	6' Straight Plug, with waterproof gland
0900820D	6' Right Angle Plug	090082AG	6' Right Angle Plug, with waterproof gland
0900810D	8' Right Angle Plug	090081AG	8' Right Angle Plug, with waterproof gland



### Wire Marking Tags & Pens

These Wire Marking Tags are intended to be used for identifying irrigation wires and cables in order to facilitate troubleshooting of systems. These tags can be used to record information on wires, decoders, Decoder Cable Fuse Devices, etcetera. Paige 270WMT (tag) and 270WMP (pen)



## RE-ENTERABLE CONNECTORS

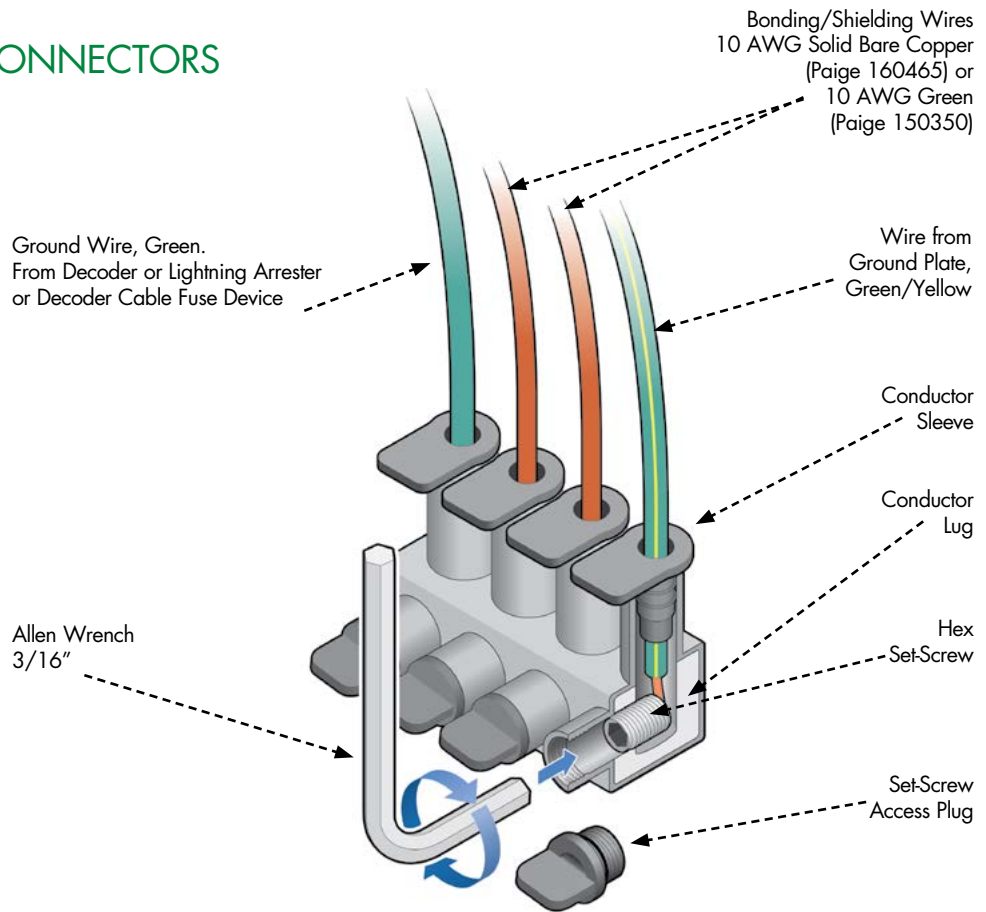

These connectors were designed for installations in wet or damp locations, and are re-enterable. The connector can be installed underground, in a valve box, in concrete or direct buried in earth. It can also be continually submerged in water to a maximum depth of 6 feet.

The Re-enterable connector can be used in conjunction with Decoders or Lightning Arresters or Decoder Cable Fuse Devices, or multiple wire connections.

The connectors are available as follows:

Part No.	No of positions
27ORC2	2
27ORC3	3
27ORC4	4
27ORC6	6 (illustrated)

Paige Electric Co., LP specifications (<http://www.paigewire.com/products.aspx?cat=16&specid=84>)

# Paige<sup>®</sup> landscapelighting

Low Voltage Lighting systems utilize a number of products. These include transformers, light fixtures, cables, timers, photo controls, waterproof connectors, etc. Paige Electric offers many of these products to: Original Equipment Manufacturers, irrigation distributors, and lighting equipment suppliers.

with varying quality and price points. Paige Electric offers many of these products to: Original Equipment Manufacturers, irrigation distributors, and lighting equipment suppliers.

## LOW VOLTAGE LIGHTING CABLES



Cables used for Professional Low Voltage Lighting direct burial and many types of applications are designed for are sunlight resistant. Paige Electric offers constructions for light fixture manufacturing and system installations. Available in a two conductor zip cord construction from 18 AWG/2c to 8 AWG/2c.

Cables used for Professional Low Voltage Lighting direct burial and many types of

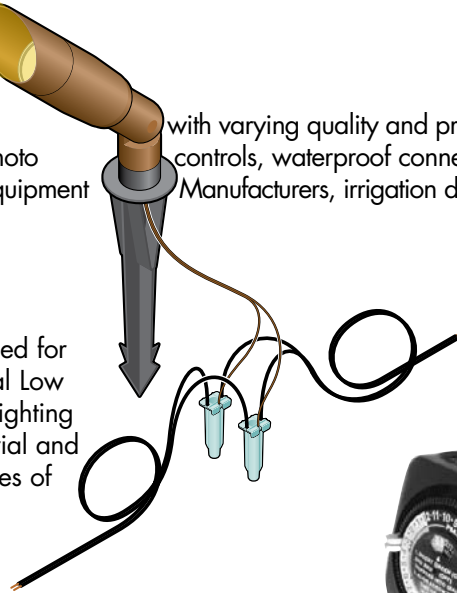

Paige Electric Co., LP specification P7190D (<http://www.paigewire.com/specs/P7190D.htm>)

## TIMERS

**Mechanical timers** are used in conjunction with Photo Controls. The photo control ensures that the lights only come on when it's dark, while the timer determines the on and off time. Paige Electric offers the only known UL-recognized timer for this specific application (270TN111RM).

270TN111RM	Intermatic Outdoor Mechanical Timer, Black, Right outlet
270422A	Tork Indoor Mechanical Timer, White, Right outlet
270403B	Tork Indoor Mechanical Timer, White, Bottom outlet



DT200LT



270422A



**Digital "Astronomic" timers** have the ability to determine sunrise and sunset for every day of the year. And, once you program the timer with information on your location, they can turn the lights on and off using any combination of sunrise, sunset, and specific on-off times. For example, the timer can be set to turn on the lights at sunset and turn them off at 11:00 PM. It could also be programmed to come back on at 5:00 AM and off at sunrise. These are available in indoor and outdoor models and are UL-listed for those applications.

270DT200LT	Intermatic Indoor Digital Timer, Astronomic, dual outlets (left & right), easy programming
270457Z	Tork Indoor Digital Timer, Astronomic, low cost, dual outlets (left & bottom)
270DT620CL	Intermatic Indoor Digital Timer, Astronomic, dual outlets (left & right)
270HB880R	Intermatic Outdoor Digital Timer, Astronomic, dual outlets, bottom



HB880R



270DT620CL



270403B

Paige Electric Co., LP specification Digital Timers (<http://www.paigewire.com/products.aspx?cat=19&specid=76>)

## PHOTO CONTROLS

These devices are used in conjunction with Low Voltage Lighting transformers and timers to ensure lights are only on when it's dark. Paige Electric photo controls feature extra long wire leads to facilitate wiring in virtually all situations.

Paige Electric Co., LP specification Photo Controls ([http://www.paigewire.com/specs/photo\\_controls.htm](http://www.paigewire.com/specs/photo_controls.htm))



2704221P



## WATERPROOF CONNECTORS FOR LOW VOLTAGE LIGHTING

Wire splices/joints are the weak link of any electrical circuit. Paige Electric offers professional grade connectors for both conventional and hub/spider lighting systems.

### MOISTURE GUARD CONNECTORS (MGC)

The MGC is an Insulation Displacement Connector (IDC.) It is ideal for splicing wires and cables in Low Voltage Lighting systems. The proven 3M concept allows the splices to be made without stripping the insulation from the wires. Just insert the unstripped wires into the holes and squeeze!



### DBR/Y-6 and DBO/B-6 CONNECTORS

The 3M™ Direct Bury Splice Kits are used to electrically connect two or more pre-stripped copper wires and moisture seal the connection for direct burial. It is ideal for splicing a wide range of wires and cables in Low Voltage Lighting systems, from 18 to 8 AWG.

### SILICONE-FILLED WIRE CONNECTORS

This family of UL and CSA listed silicone-filled wire connectors was specifically designed for use in professionally installed irrigation control and landscape lighting systems. These connectors provide a secure electrical connection for two or more pre-stripped copper wires and seal the connection for use in damp/wet locations or direct bury applications. Connected and protected in one easy, time-saving process.



Part Numbers and Description													
													
		Gray/Orange				Gray/Red				Gray/Dark Blue			
Wire Range	AWG	22-14				18-8				16-6			
	mm <sup>2</sup>	0.34 to 2.5				0.75 to 10				1.5 to 16			
Replaces King		Black/White, Gray/Gray, Aqua/Orange, Blue/Blue				Black/Gray, Aqua/Red, Tan				Black/Blue, Aqua/Blue			
Packaging Details		Pack	Case Qty	Paige #	Ideal #	Pack	Case Qty	Paige #	Ideal #	Pack	Case Qty	Paige #	Ideal #
		Card of 25	125	270i61B	30 - 1161	Card of 20	100	270i62B	30 - 1162	Card of 15	75	270i63B	30 - 1163
		Jar of 150	900	270i61J	30 - 1261J	Jar of 100	600	270i62J	30 - 1262J	Jar of 50	300	270i63J	30 - 1263J
		Box of 1000	1,000	270i61D	30 - 1361	Box of 1000	1,000	270i62D	30 - 1362	Box of 1000	1,000	270i63D	30 - 1363

Paige Electric Co., LP specifications (<http://paigewire.com/specs/P7372D.htm>)

## LOW VOLTAGE LIGHTING COMPONENTS

Paige Part No.	Description
180xxx	Low Voltage lighting cables, 18 to 8 AWG, 2-conductors (zipped)
270TN111RM	Intermatic Outdoor Mechanical Timer, Black, Right outlet
270422A	Tork Indoor Mechanical Timer, White, Right outlet
270403A	Tork Indoor Mechanical Timer, White, Bottom outlet
270457Z	Tork Indoor Digital Timer, Astronomic, low cost, dual outlets (left & bottom)
270DT620CL	Intermatic Indoor Digital Timer, Astronomic, dual outlets (left & right)
270HB800RC	Intermatic Outdoor Digital Timer, Astronomic, dual outlets, bottom
270K4221	Photo Control, swivel mount
270672	DBR/Y-6 waterproof connectors, 18 to 10 AWG
270MGC	Moisture Guard waterproof connectors, 14 to 12 AWG
270iXXX	Silicone-filled Twist-on Connectors, 18 to 8 AWG
270MH14BCX	3M Crimp-n-Shrink, Water resistant butt connector 18-14 AWG
270MH10BCX	3M Crimp-n-Shrink, Water resistant butt connector 18-10 AWG
270WMT	Wire Marking Tag
270WMP	Wire Marking Pen



FOR TECHNICAL ASSISTANCE,  
OR HELP IN LOCATING OUR NEAREST WORLDWIDE DISTRIBUTOR(S),  
PLEASE CONTACT US AT THE LOCATIONS BELOW:

Name(s)	Location	Phone	Fax	E-mail	Skype
Vince Nolletti	Fresno, CA	559.431.2346	559.431.2574	vnolletti@paigeelectric.com	vincent.nolletti
Katrina Nolletti				knolletti@paigeelectric.com	kat2n2
Larry Thull				lthull@paigeelectric.com	
Nancy Di Rienzo	Union, NJ	908.687.7810	908.687.2722	ndirienzo@paigeelectric.com	nanner.nd
Dave Di Rienzo				ddirienzo@paigeelectric.com	ddirienzo
Dave Teed				daveteed@paigeelectric.com	baker35188
Joe Di Rienzo	Taipei, Taiwan	886.958.303036	886.2.2706.3101	jdirienzo@paigeelectric.com	huangdijoe
Mark Haas	Anaheim, CA	714.280.0109	714.280.1079	mhaas@paigeelectric.com	
Michelle Haas				michellehaas@paigeelectric.com	
Ryan Haas				rhaas@paigeelectric.com	

## DISCLAIMER

Paige Electric has made every effort to ensure that the information and recommendations contained within are correct. However, neither Paige Electric nor any of its employees warrants nor accepts any liability for the use of this information. National and local electrical codes should always be followed. Wiring, grounding, shielding, and bonding irrigation system components often require competent engineering judgement on a case-by-case basis. Competent engineering assistance should be sought from firms specializing in this field.

## PAIGE ELECTRIC WARRANTY

Paige Electric Company, L.P. ("Paige") warrants that it owns all intellectual property rights, title and interest or has the right to license such rights to each of the product(s) sold by it ("Product(s)") and warrants to the Purchaser that each Product is free from defects in material and workmanship and conforms to any applicable specifications required by Purchaser and which are attached to this Warranty.

Purchaser can make no claim against Paige based on the sale of the Product(s) subject to this Warranty unless the facts giving rise to such claim(s) are discovered or could reasonably have been discovered by diligent inquiry within twelve (12) months of shipment from Paige and Purchaser provides written notice to Paige within thirty (30) days of discovery. The Warranty stated in this paragraph is exclusive of all other warranties, written or oral, statutory, express or implied, none of which shall apply to the sale of the Products. Paige expressly disclaims any warranty of merchantability or fitness of the Product for a particular purpose.

This Warranty shall not apply to any Product that has been subject to misuse, mishandling, accident, alteration, neglect, unauthorized repair or installation. Furthermore, this Warranty shall not apply to the use of Products in an application or environment that is inconsistent with its specifications or in the event of any act, error, neglect or default of Purchaser.

PURCHASER'S SOLE REMEDY WITH RESPECT TO ANY BREACH OF THIS WARRANTY SHALL BE THE REPAIR OR REPLACEMENT OF THE PRODUCT(S). PAIGE IS NOT RESPONSIBLE FOR DIRECT, SPECIAL, INCIDENTAL, OR CONSEQUENTIAL DAMAGES RESULTING FROM ANY BREACH OF WARRANTY OR UNDER ANY OTHER LEGAL THEORY INCLUDING, BUT NOT LIMITED TO, LOST PROFITS, DOWNTIME, GOODWILL, DAMAGE TO OR REPLACEMENT OF EQUIPMENT AND PROPERTY.

THE LAW OF THE STATE OF NEW JERSEY, USA SHALL APPLY TO ANY CLAIMS REGARDING PRODUCTS COVERED BY THIS WARRANTY AND THE EXCLUSIVE JURISDICTION FOR ANY SUCH CLAIMS SHALL BE THE STATE AND FEDERAL COURTS OF NEW JERSEY.

Lengths of cable, which have been replaced by Paige in accordance with the foregoing, shall become the property of Paige and shall be returned to it by the Purchaser, F.O.B. point of shipment.

The warranty for products produced by companies other than Paige (3M, IDEAL, Intermatic, LORESCO International, ERICO, etc.) is often stated in its product literature, which is usually available on their websites. For assistance in this matter, please contact Paige Electric.

08/15/2017

Quality irrigation cables, accesories and service since 1958.

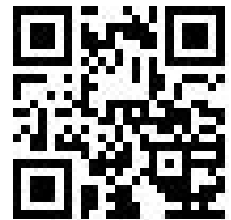

[www.paigewire.com](http://www.paigewire.com)